

Product Description

ATEK354N4 is a voltage variable attenuator housed in 4x4 mm surface mount package. Attenuator operation range covers LF - 35 GHz. Usable band goes down to kHz region and high frequency range goes up to 40 GHz.

RF input outputs are matched to 50 ohms internally.

Evaluation Board, bare die, custom package, and module options are available upon request.

Product Features

- Frequency Range: LF - 30 GHz
- Insertion Loss: 1.4 dB at 10 GHz
- Attenuation Range: 42 dB at 10 GHz
- 4x4 mm compact size

Applications

- Wideband Receivers
- Telecommunication
- SATCOM
- Test Equipment
- SDR

Functional Block Diagram

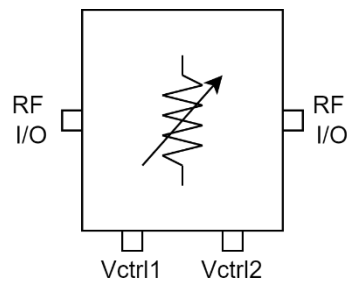

Electrical Specifications

Conditions unless otherwise specified: T = 25 C, CW.

Parameter		Min	Typ	Max	Units
Operational Frequency Range		LF		35	GHz
Attenuation	0.01 GHz		1.3		dB
	2 GHz		1		
	6 GHz		1.1		
	12 GHz		1.7		
	18 GHz		1.8		
	26.5 GHz		2.1		
	35 GHz		3		
Attenuation Range	0.01 GHz		32		dB
	6 GHz		39		
	12 GHz		43		
	18 GHz		45		
	26.5 GHz		45		
	35 GHz		46		
Input Return Loss			-16		dB
Output Return Loss			-16		dB
Input P1dB			TBD		dBm
Input IP3			23		
Switching Speed	On		TBD		ns
	Off		TBD		
DC Control Voltage (V _{CTRL1} , V _{CTRL2})		-3		0	V
DC Control Current (I _{CTRL1} + I _{CTRL2})			3		mA
Operating Temperature		-40		85	°C

Typical Performance Plots

Conditions unless otherwise specified: T = 25 C, CW.

Attenuation

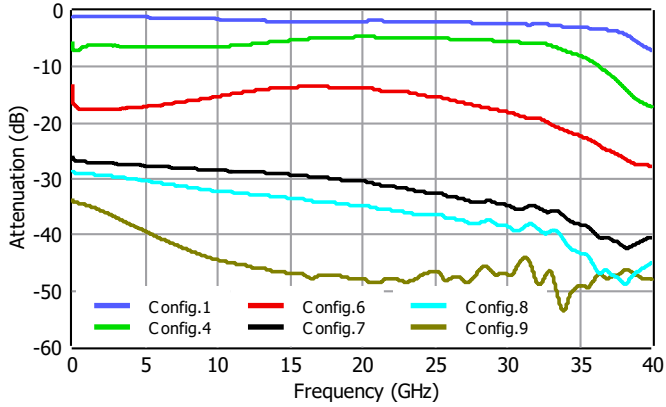

Insertion Loss at Vctrl1,2 Configuration 1

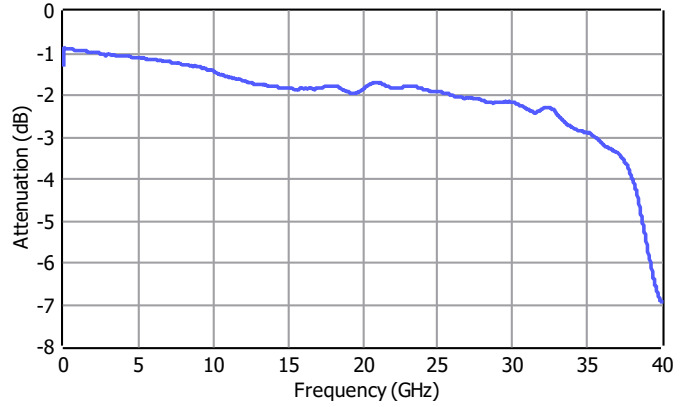

Normalized Attenuation

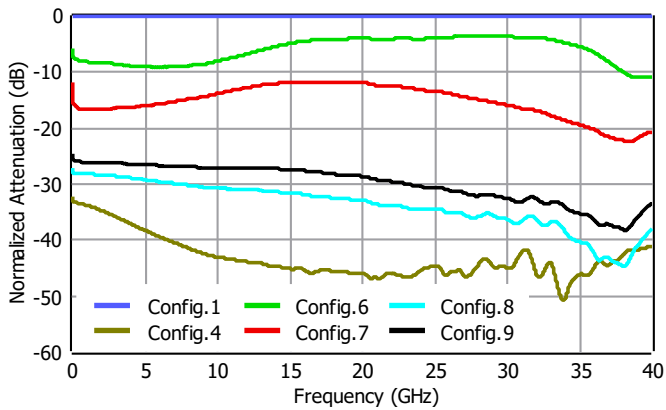

Input Return Loss

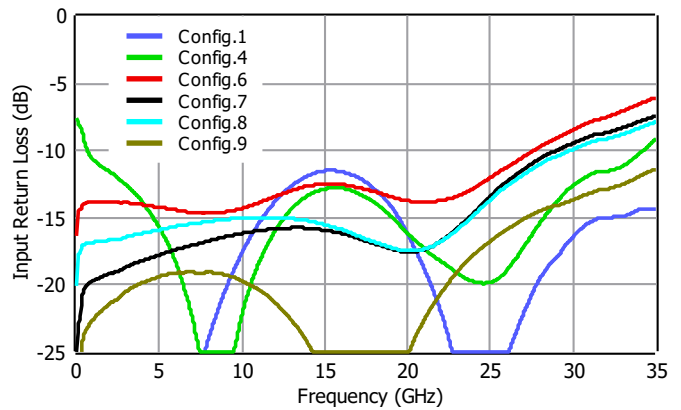

Output Return Loss

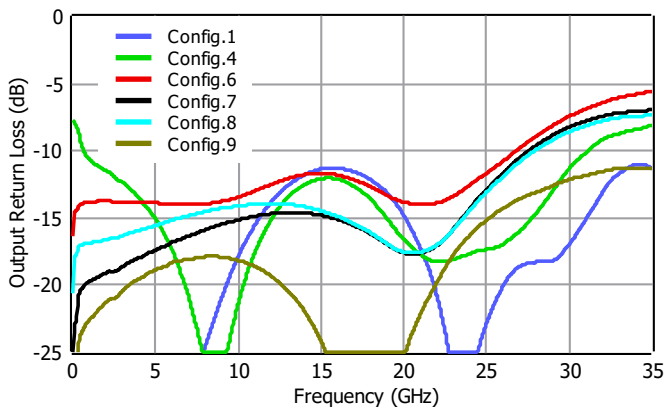

Attenuation Range

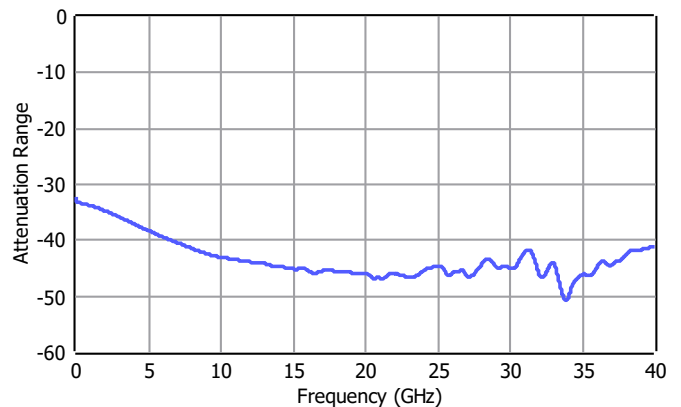

Typical Performance Plots

Conditions unless otherwise specified: T = 25 C, CW.

Attenuation vs Vctrl1,2 Configuration at 10GHz

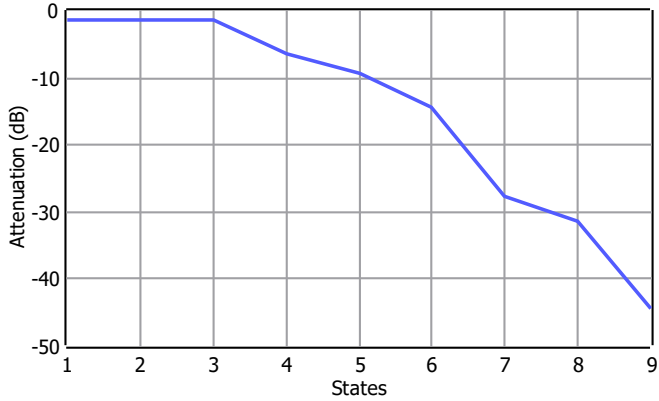

Attenuation vs Input Power at 10 GHz

TBD

Input IP3 at Vctrl1,2 Configuration 1

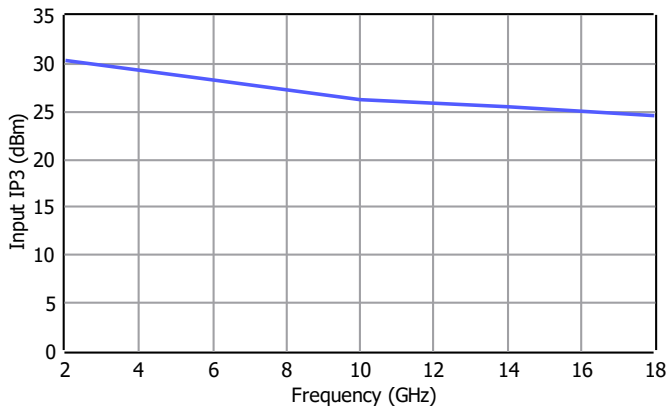

Input IP3 vs Vctrl1,2 Configuration at 10 GHz

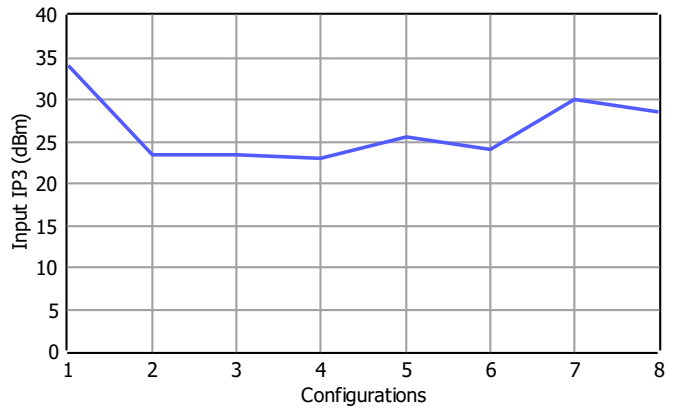

Input P1dB at Vctrl1,2 Configuration

TBD

Input P1dB vs Vctrl1,2 Configuration at 10 GHz

TBD

Pin Description

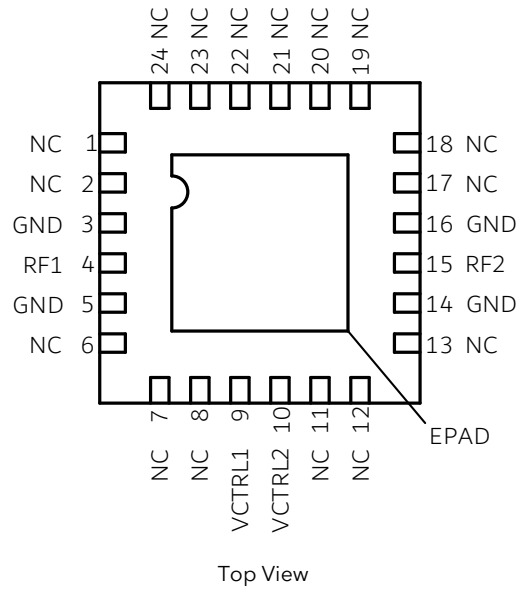

Pin Number	Pin Name	Description
4	RF1	RF input, output pin. If the DC voltage level on RF lines is not equal to 0 V, an external DC block capacitor is required.
15	RF2	RF input, output pin. If the DC voltage level on RF lines is not equal to 0 V, an external DC block capacitor is required.
9	VCTRL1	Control Voltage Pin.
10	VCTRL2	Control Voltage Pin.
1 - 2, 6 - 8, 11 - 13, 17 - 24	NC	These pins are not internally connected. Can be grounded on the PCB.
3, 5, 14, 16	GND	Ground.
25	EPAD	Exposed Pad on the bottom of the package should be connected to ground with multiple number of vias to reduce the inductance to the GND.

Control Interface

V _{CTRL1}	V _{CTRL2}	Configuration
0	-3	Config.1
0	-2	Config.2
-0.1	-2	Config.3
-0.5	-1.5	Config.4
-0.7	-1.5	Config.5
-0.7	-1.1	Config.6
-0.7	-0.7	Config.7
-0.9	-0.6	Config.8
-0.7	0	Config.9
0	-1	Config.10

Applications Information

Signal entering from RF IN goes to RF OUT with an amplification.
Typical application schematic to operate the attenuator is given below.

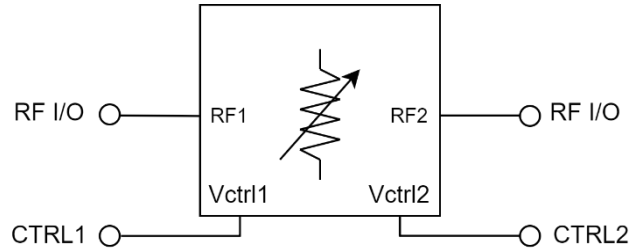

The attenuation level of the voltage variable attenuator is controlled through Vctrl1 and Vctrl2 pins. A voltage level in between -3 V to 0 V can be applied to those pins to set the attenuation level. For ease of use, Vctrl1 and Vctrl2 pins can be shorted, and single CTRL voltage can be applied.

To filter out the ripples and unwanted signals on the external CTRL signal, a low pass filter in series R, shunt C configuration can be implemented on the Vctrl1 and Vctrl2 lines. Note that external RC filtering limits the attenuation switching speed of the attenuator. If filtering the external CTRL signal is of no concern, then the attenuator can be operated without any additional external components.

Large signal datasheet plots are generated by connectorized evaluation boards (EVBs), PCB and connector losses are de-embedded. Small signal plots are generated by probing the RF lines with RF probes to eliminate the connector transition effects.

NC pins are connected to the GND on the EVBs used to generate the plots shown in this document.

As shown on the plots below, different Vctrl1, Vctrl2 configuration can provide similar attenuation level with different attenuation slopes. As an example, Vctrl1, Vctrl2 Configuration 6 and Configuration 10 provides similar attenuation levels at 18 GHz, where the attenuation levels at 1 GHz are different than 18 GHz levels. This lets user to utilize the attenuator with different attenuation slopes, by adjusting Vctrl1 and Vctrl2 levels.

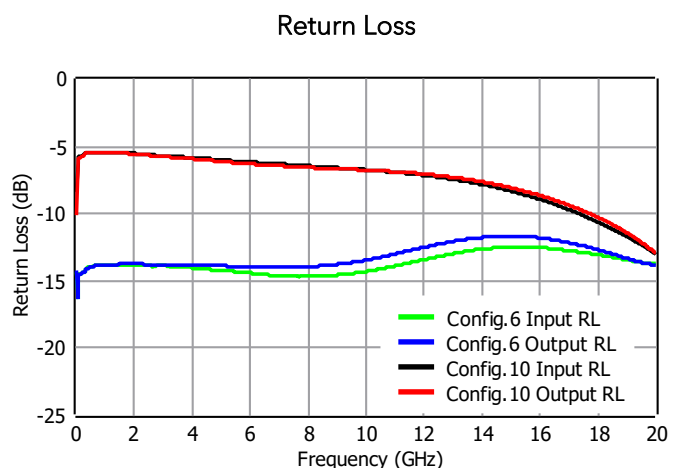
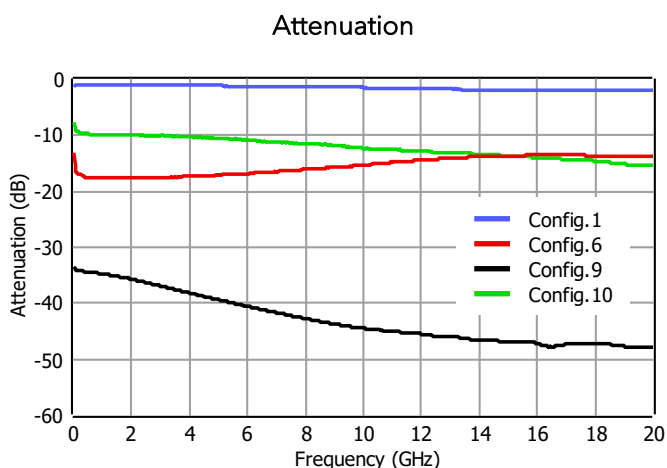

Absolute Maximum Ratings

Parameter	Value/Range
Supply Voltage (Vdd)	TBD
RF Input Power	TBD
Storage Temperature	-55 to +125°C

Operation of this device outside the parameter ranges given above may cause damage. These conditions should not be applied simultaneously.

Mechanical and Marking Information

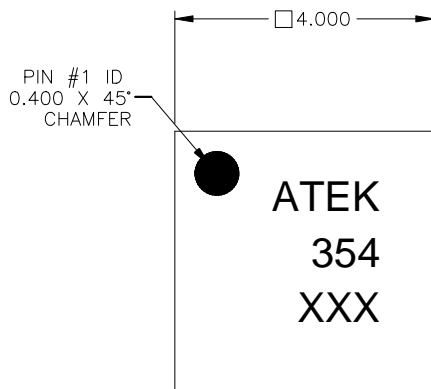

TOP VIEW

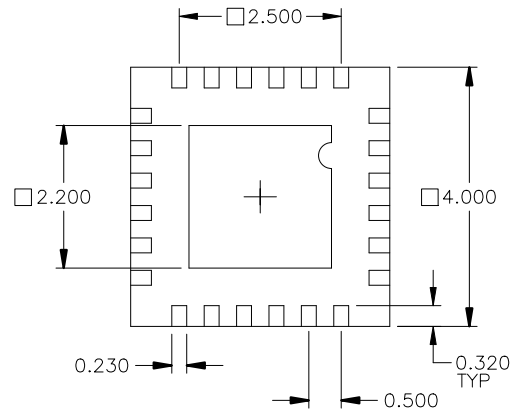

BOTTOM VIEW

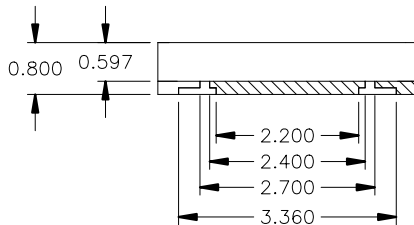

SECTION A-A

NOTES

1. JEDEC OUTLINE: MO-220
2. ALL DIMENSIONS IN MM
3. TOLERANCE IN X.XX= ± 0.15 X.XXX= ± 0.050

Handling Precautions



Caution!
ESD-Sensitive Device
Handle Accordingly

Contact Information

For the latest specifications, additional product information, support, and sales.

Web: www.atekmidas.com

Tel: +90-212-483-71-67

Email: support@atekmidas.com

Notice

This document and its contents are property of ATEK MIDAS. ATEK MIDAS has the right to change the document at any time without notice. ATEK MIDAS distributes this document as a service to its customers. ATEK MIDAS supports its customers to help them create market leader products. Customer is responsible from choosing the product and the configuration the product. This document is provided `as is` and does not provide any warranty.

Customer is responsible for the usage of this document, the information provided in the document and the usage of products. ATEK MIDAS shall have no responsibility from the customer products, customer applications and doings of customers.

Revisions

Revision No	Revision Date	Revision Reason	Section / Page No
1.0	22.09.2022	Initial Release	